



3590ET / 3590EGT

Touch screen indicator

CONNECTION DIAGRAMS

ENGLISH



Table of contents

Introduction	4
Electrical warnings	5
Electrical precautions	5
Cable classification	5
Recommended distance between cables	6
Maximum permitted length of cables	6
Earthing system	7
Example of weighbridge earthing	8
Example of silos earthing	9
Motherboard	10
I/O expansion board	12
Optional internal board for rapid connection of multiple scales	13
RJ45 RS232 connector board	13
RS232 / RS485 to Ethernet / WIFI conversion board	14
USB support data saving board	16
RADIO communication board	17
PROFIBUS communication board	17
BLUETOOTH communication board	18
RADIO REMOTE CONTROL board	18
Circuit breaker against electrostatic loads	18
Analog output	19
Traffic light	20
RS485	20
RS485 opto-isolated board	21
Display board	21

Dear Customer,

Thank you for purchasing a DINI ARGEO product.

This manual contains all instructions for proper installation of the weight indicator with touch screen series 3590.

We thank you for purchasing this scale and we kindly ask you to take note of certain aspects of this manual:

This booklet provides useful information for proper operation and maintenance of the scale referred to herein. It is important to pay the utmost attention to all the sections that illustrate the simplest and safest way to operate the device.

This publication, or portions thereof, may not be duplicated without written permission from the Manufacturer.

All information herein is based on the data available at the time of publication. The Manufacturer reserves the right to make changes to its products at any time without notice and without incurring any penalty. We therefore recommend that you always check for any updates.

N.B.: The individual in charge of operating the scale must ensure that all safety regulations in force in the country of use are applied, ensuring that the appliance is used in accordance with the purpose it is intended for and to avoid any danger for the user.

The manufacturer declines any liability arising from any weighing operation errors.

We recommend carefully following the instructions when programming the weight indicator, as to do otherwise could jeopardise proper scale operation.

This manual was written with the utmost care but we always welcome feedback on any inaccuracies you may find.

The instrument is covered by warranty and **MUST NOT BE TAMPERED WITH BY THE USER** for any reason.

Any attempt to repair or modify the device could expose the user to the risk of electrical shock and will render all warranty conditions null, thus releasing the Manufacturer from all liability.

All problems with the unit or system must be communicated to the manufacturer or the dealer from which it was purchased. In any case, **DISCONNECT POWER** before any operations.

Electrical precautions

- Mains power supply adjusted within $\pm 10\%$ of the nominal voltage
- Electrical protections (fuses, etc.) are to be provided by the installer.
- Comply with the minimum recommended distances between different categories of cables.
- The load cell or signal amplifier extension cables, which are used for serial port and analog output connection, must comply with the maximum permitted lengths.
- The load cell or signal amplifier extension cables, which are used for serial port and analog output connection, must be shielded and must also be inserted alone into the conduit or metal pipe.
- Cell or amplifier cable input into the electrical panel must be autonomous. If possible, they must be connected directly to the indicator's terminal board without passing through the conduit with other cables.
- Install an "RC" filter on coil contactors, solenoid valves and all devices that generate electrical interferences.
- If condensation can develop inside the scale's transmitter, it is recommended to keep the equipment running.
- With regard to all shielded and non-shielded cables (cell cable, PC cable, power supply cable, etc.) that are connected to the indicator, you must keep the cable as short as possible and make a minimum amount of the cables exit from the shield in order to be connected to the terminal board;
- If the indicator is situated inside an electrical panel, you must also use a shielded cable for power supply and must keep the cable as short as possible and far from the cables supplying coils, inverter, electromotive force, etc., and apply a de-coupling transformer to supply the indicator only.

Cable classification

The various cables are classified according to the signals they transmit:

Category I

- Fieldbus , LAN network (PROFIBUS, Ethernet, Devicenet...)
- Data shielded cables (RS232 ...)
- Shielded cables for analog digital signals < 25V (sensors, load cells.)
- Low-voltage power supply cables (<60V)
- Coaxial cables

Category II

- DC power supply cables with >60V and <400V
- AC power supply cables with >25V and <400

Category III

- Power supply cables with >400V
- Telephone cable

Category IV

- Any cables subject to lightning hazards

Recommended distance between cables

- When cables are laid parallel, they must be at the distances specified in the figure below
- These distances are intended in the air and are reduced if the housings are separated by metal boards connected to the ground
- Cables from different categories can cross (90°)

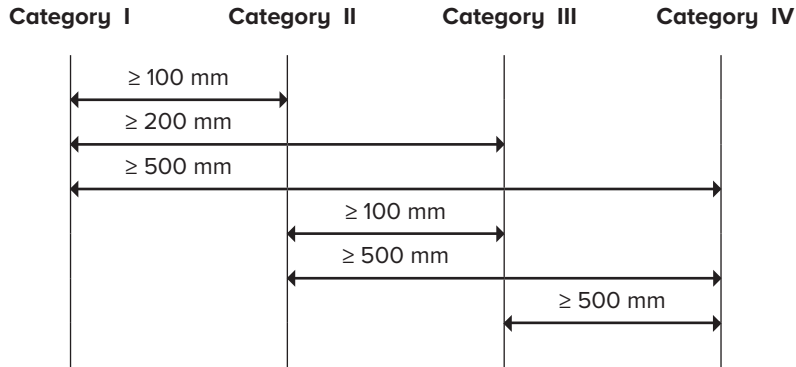

Maximum permitted length of cables

LOAD CELL CONNECTION CABLE

The relative cable can reach the following maximum length from the line in order to connect the load cells:

- 50 metres with a 6×0.25 mm² cable
- 100 metres with a 6×0.5 mm² cable

RS232 CONNECTION CABLE

The relative cable can reach a maximum length of approximately 15 metres from the line for RS 232 connections, with a baud rate of up to 19200.

RS485 CONNECTION CABLE

The relative cable can reach a maximum length of approximately 1200 metres from the line with a baud rate of up to 9600.

ANALOGUE OUTPUT CONNECTION CABLE

The maximum length for current analog output is:

- 100 metres with a 2×0.25 mm² cable
- 150 metres with a 2×0.5 mm² cable
- 300 metres with a 2×1 mm² cable

The maximum length for voltage analog output is:

- 50 metres with a 2×0.25 mm² cable
- 75 metres with a 2×0.5 mm² cable
- 150 metres with a 2×1 mm² cable

Earthing system

For correct earthing and perfect system operation, you must connect the indicator, load cells, any junction boxes and weighing structure to earth.

INDICATOR

Connect the container's external earth terminal to earth with copper cables having a minimum dimension of 16 mm².

LOAD CELLS AND JUNCTION BOX

Earthing must be carried out by connecting the earthing cables to the earth bar; the cables must have a minimum dimension of 16 mm². Also, connect the earth bar to the earth pole with a minimum cable of 50 mm².

- If the load cells are connected to the indicator via a junction box, you must connect the cable shield from the indicator and the cell cable shields to the earth terminal of the junction box (refer to the junction box manual) and connect the latter to earth by means of a copper cable having a minimum dimension of 16 mm².
- If the load cells are connected directly to the indicator (without using a junction box), you must connect the cell cable shields to the earthing point (or earth bar) inside the container.
- If the weighing system is for a large and/or outdoor structure, such as a weighbridge, and the junction box is connected to the indicator with a cable longer than 10 m, or if there are interferences, connect the cable's braiding from the indicator to the earth terminal in the junction box and indicator and connect the two earth systems with an earth cable having a minimum dimension of 16 mm².

WEIGHING STRUCTURE

Connect the weighing structure and any other structures that are not connected (for example silos that leave material on the weighing structure) to earth with cables having a minimum dimension of 16 mm².

You must also connect the upper part of each cell with the lower part of the cell with a copper braid having a minimum dimension of 16 mm². The upper part must be short circuited with the surface of the weighing structure and the lower part must be connected to earth with a copper braid having a minimum dimension of 16 mm².

SERIAL CABLES AND INSTRUMENTS CONNECTED

Connect the serial cable shield to the earthing point (or earth bar) inside the container (on the end part of the cable towards indicator) and to the earth terminal of the connected instrument (on the end part of the cable towards the instrument connected), and connect the earth terminal of the connected instrument to earth with copper cables having a minimum dimension of 16 mm². To avoid undesired effects, the earthing references of the connection cable and power supply of the instrument connection and the indicator must have the same power.



NOTES:

- All earth cables must have a suitable length in order to obtain an **overall resistance of the earthing system below 1Ω**.
- With regard to large and/or outdoor weighing system structures, such as a weighbridge:
 - connection to earth must be carried out by connecting the earth cables to an earth bar, and the earth bar to an earth pole with a minimum cable of 50 mm².
 - The cables must be larger (e.g. 50 mm² instead of 16 mm² and 100 mm² instead of 50 mm²) since the voltage involved is higher (e.g. lightning);
 - the earth pole must be situated at a minimum distance of 10 m from the weighbridge structure;
- You must open SENSE inside the indicator in order to compensate for the shift due to an increase in temperature.
- You must check and, if necessary, remove the connection between electrical installation earth and neutral.



Example of weighbridge earthing

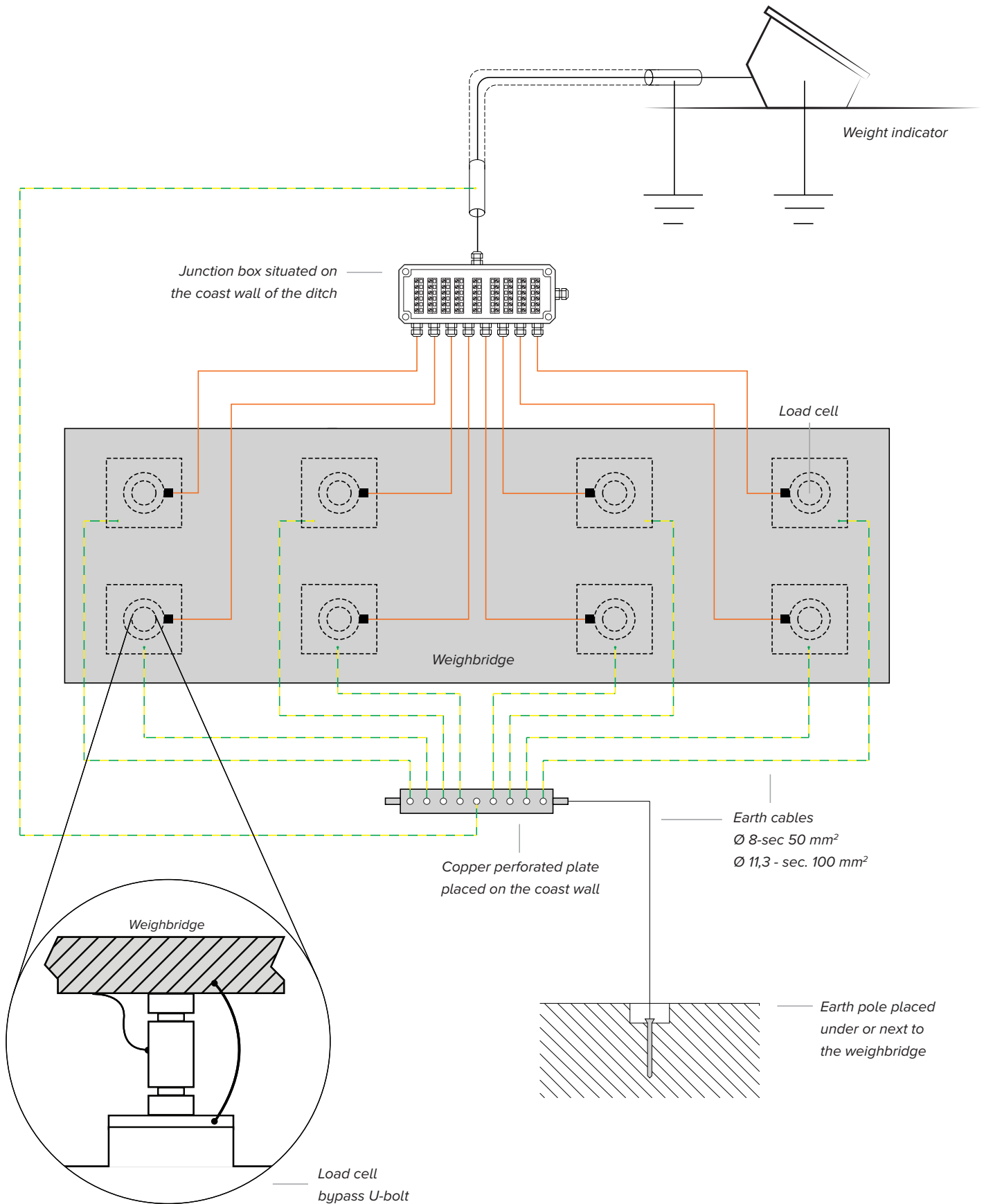

Example of silos earthing

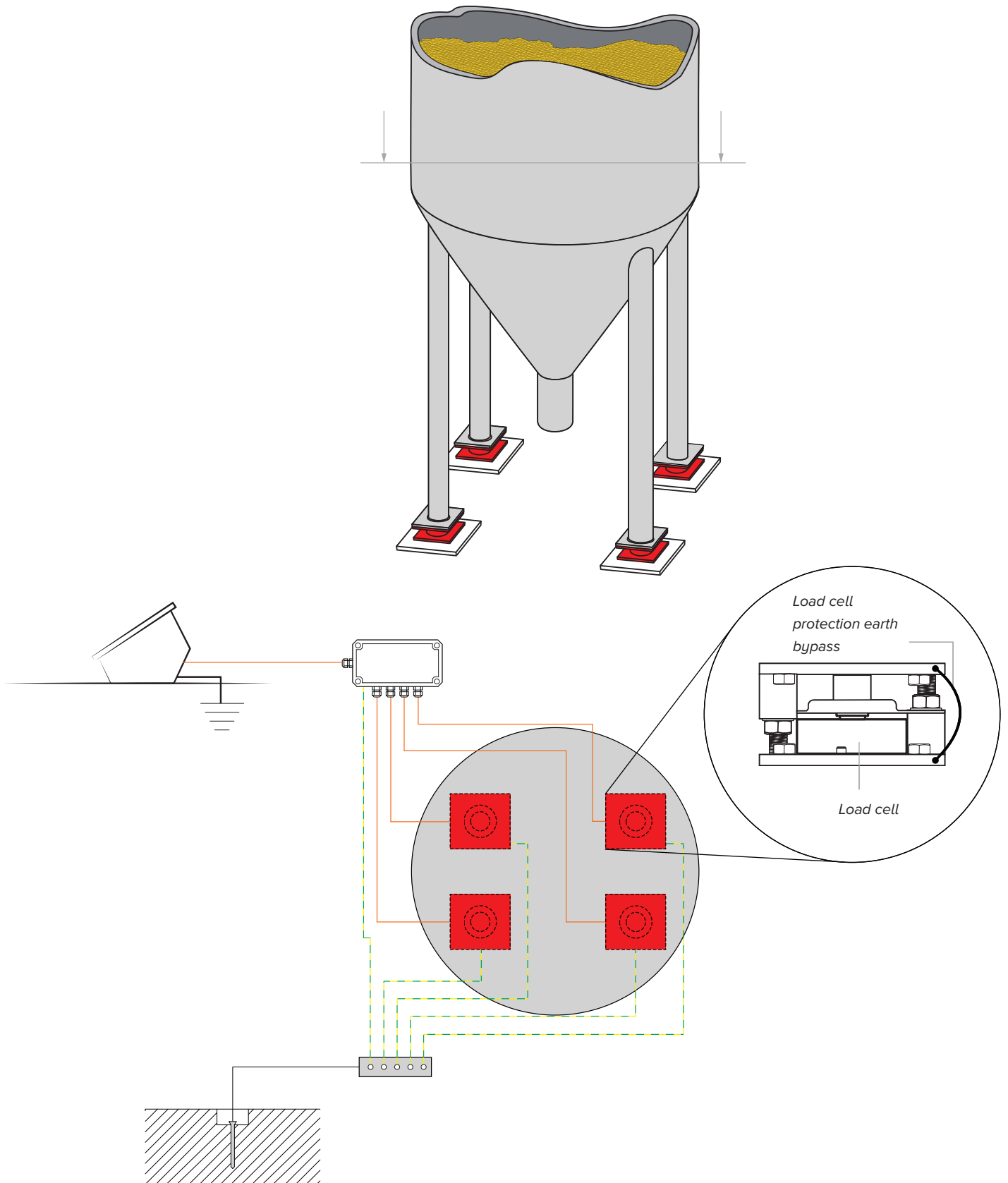

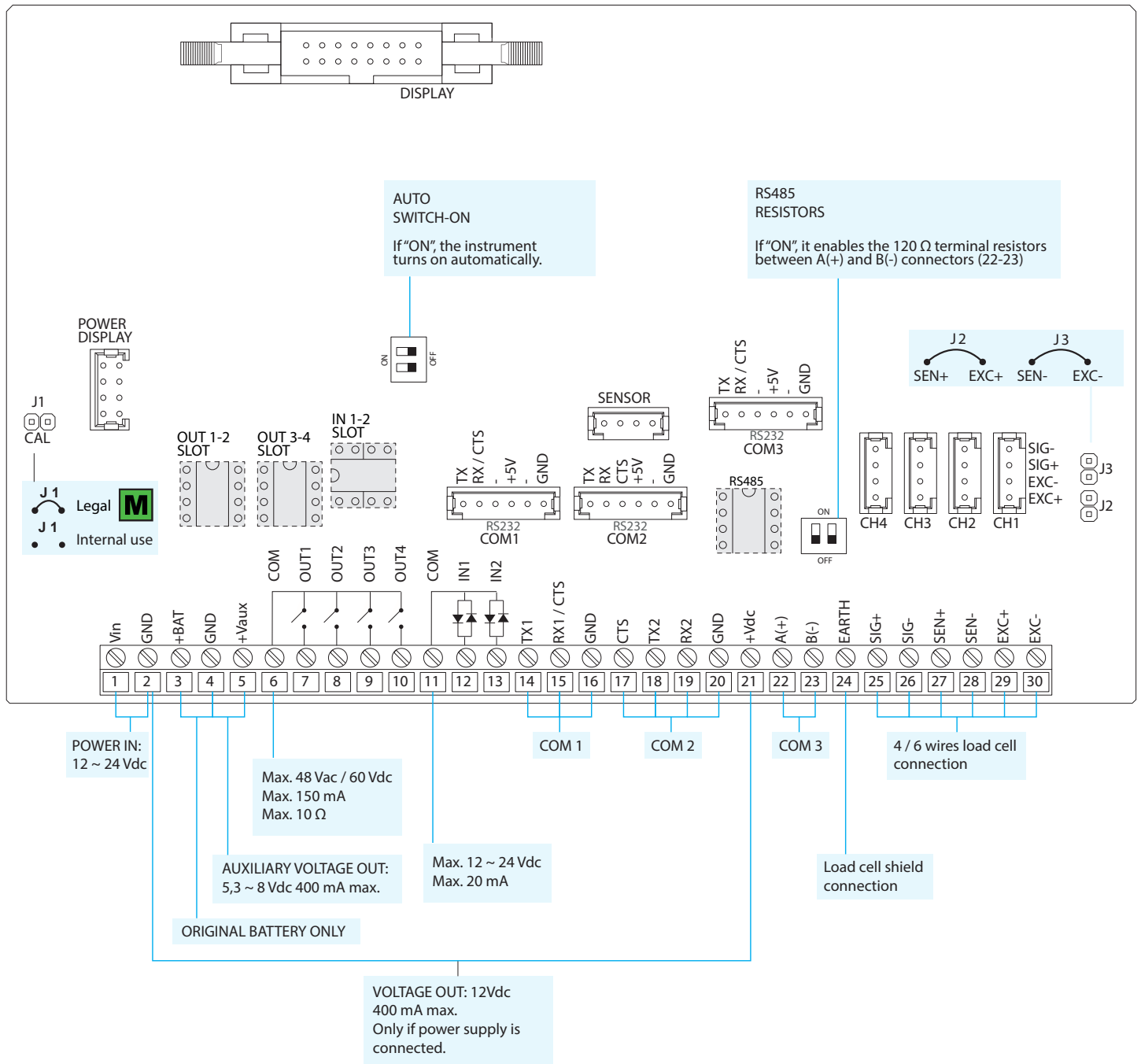

INPUT AND OUTPUT CONNECTION

OUTPUT

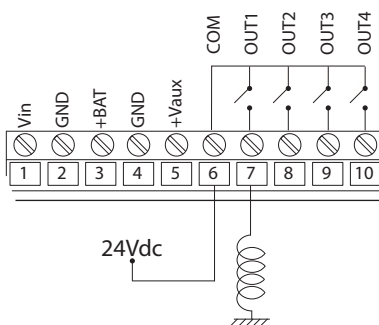

INPUT

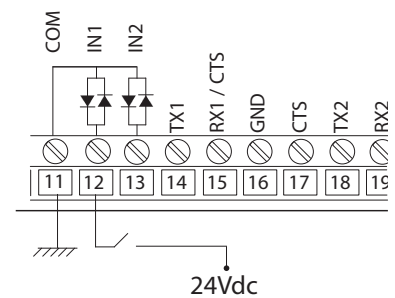

OUTPUT

INPUT

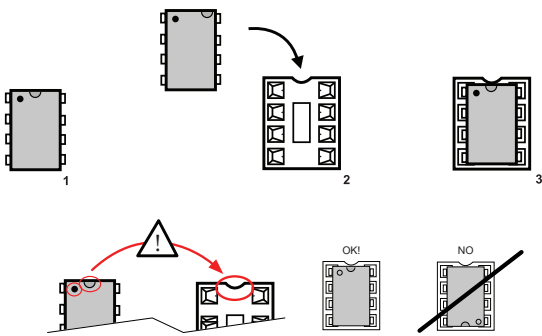

3590

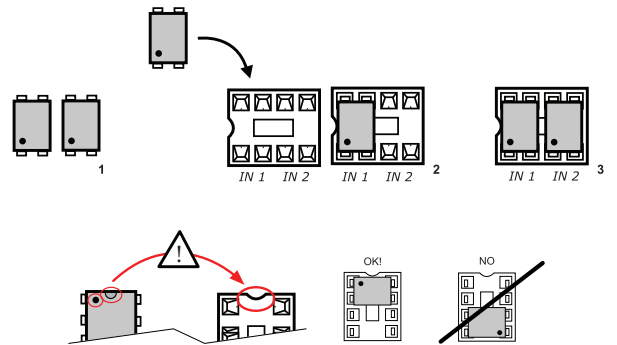
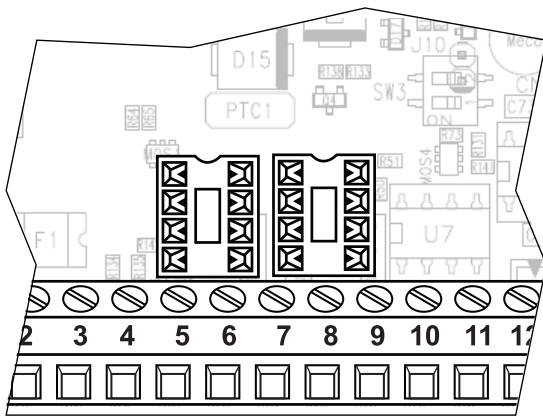

3590

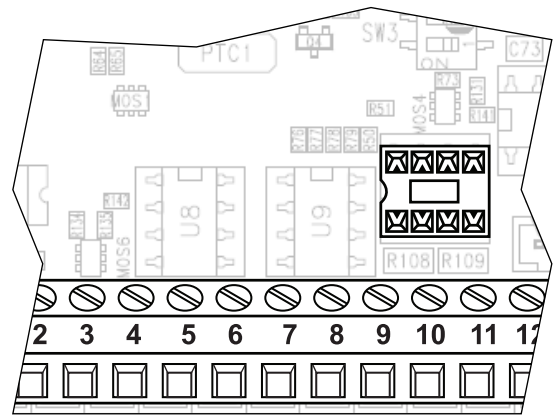

I/O expansion board

installation integrated inside the scale. 12 OUT and 8 IN; enables expansion of scale power supply up to 8-40Vdc.

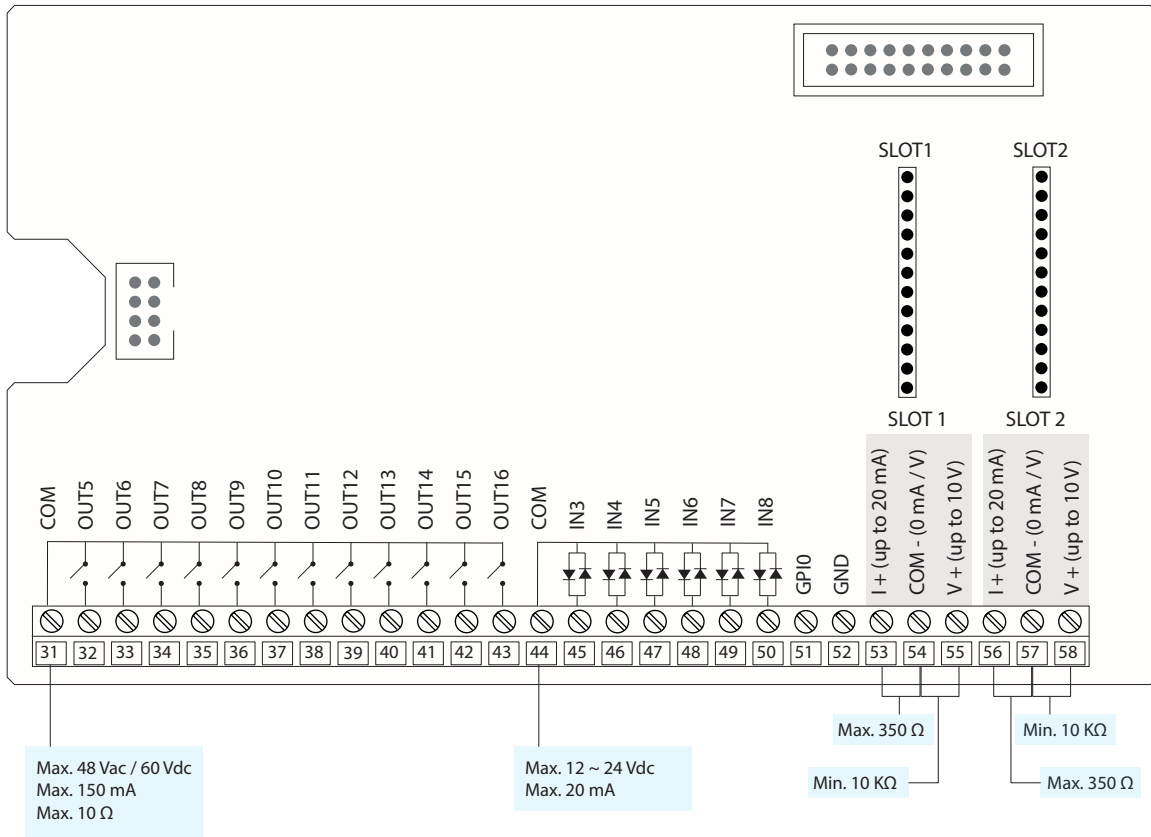

Connection:

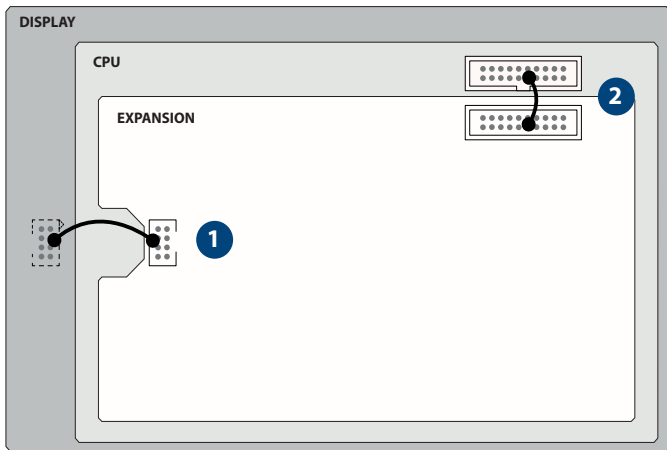

INPUT AND OUTPUT CONNECTION

OUTPUT

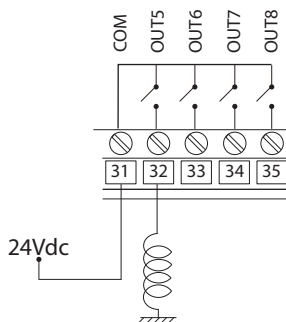

INPUT

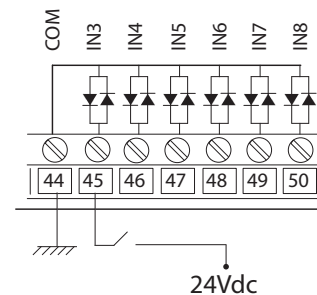

Optional internal board for rapid connection of multiple scales

Multi-scale fitting board

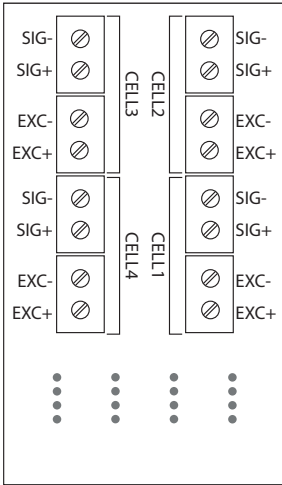

Installation:

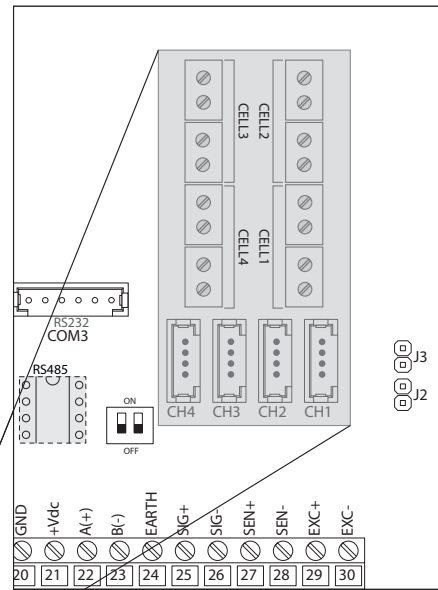

Motherboard

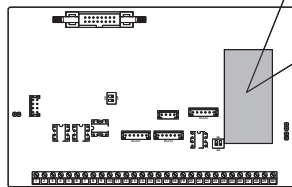

RJ45 RS232 connector board

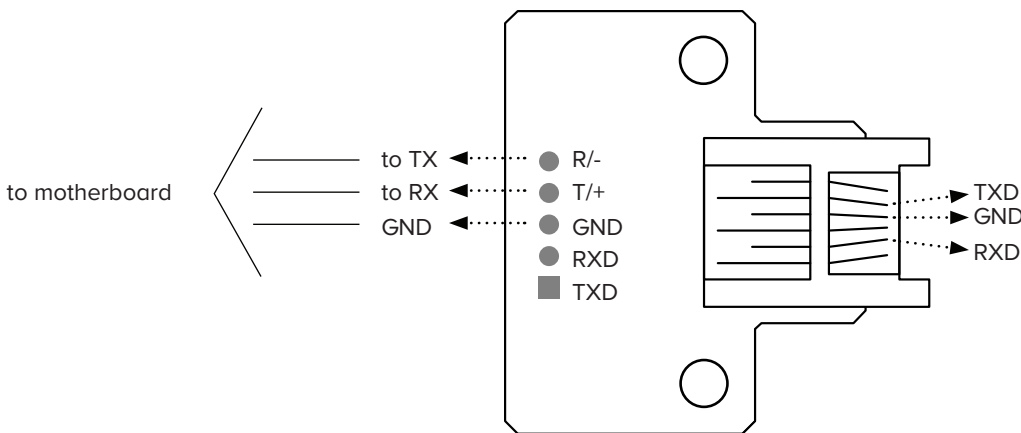

The AMP connector enables you to rapidly connect and supply the CPU board of the weighing indicator.



RS232 / RS485 to Ethernet / WIFI conversion board

Installation integrated inside the scale.

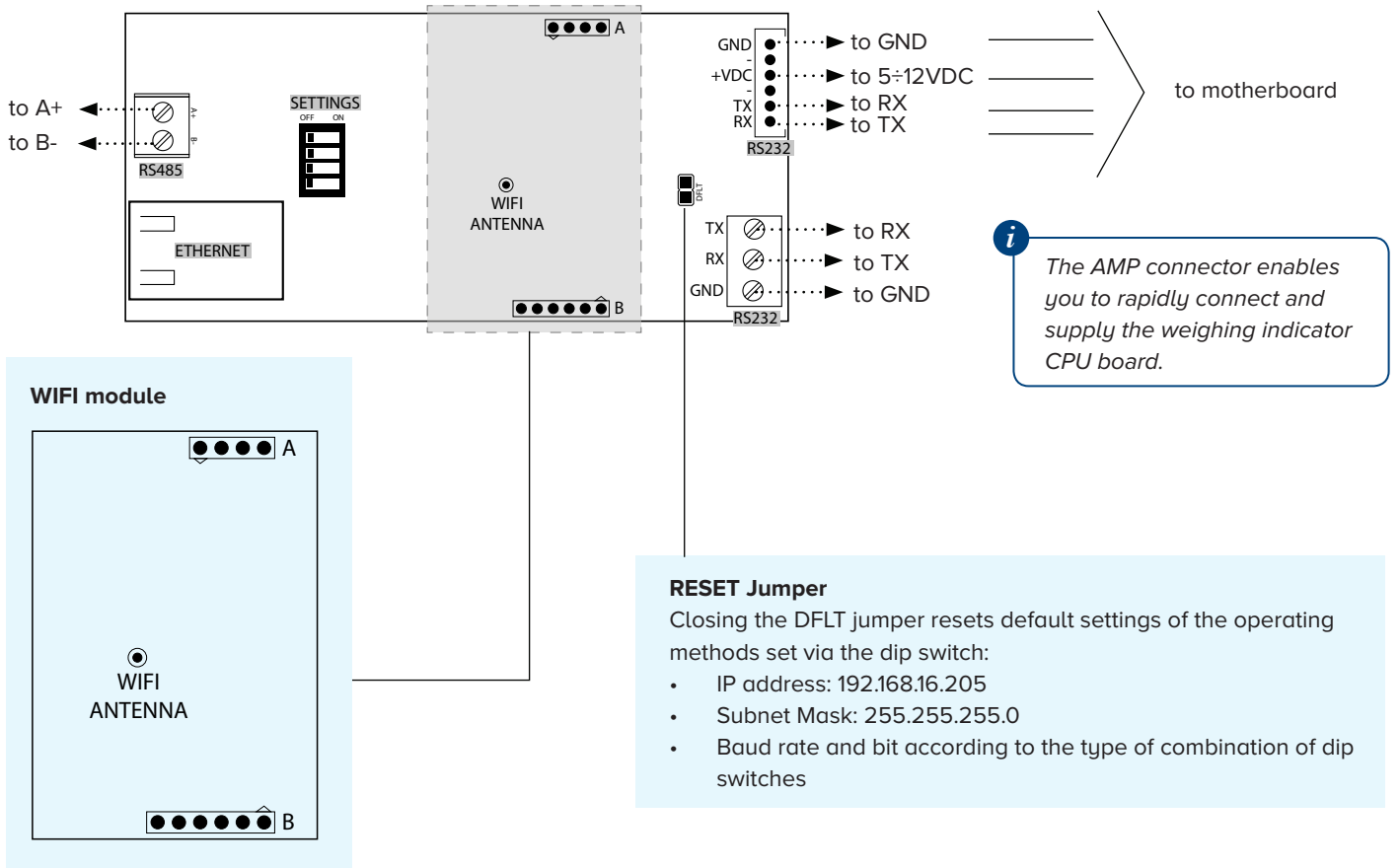

Version for installation on a DIN bar

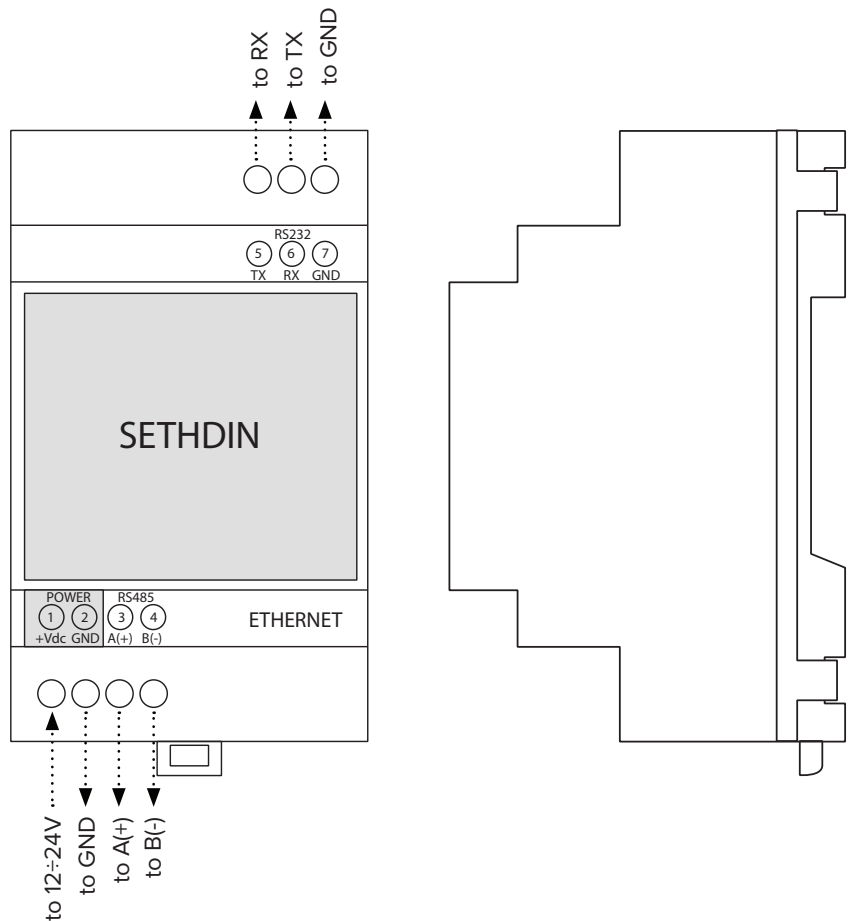

SETTINGS:

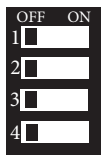

ETHERNET/WIFI conversion in «232/485» and vice-versa

WARNINGS:

RS232 and RS485 communication ports cannot be used simultaneously.
Set the serial ports to 9600 n-8-1.

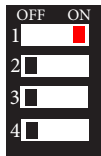

Network between instruments on RS232

Port 485 available for simultaneous communication to other devices.
Set the serial ports to 115200 n-8-1.

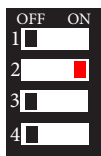

Modbus RTU converter in Modbus TCP

Convert Modbus RTU protocol to Modbus TCP.

RS232 and RS485 communication ports cannot be used simultaneously.
Set the serial ports to 9600 n-8-2.



It enables you to rapidly connect and supply the weighing indicator CPU board.

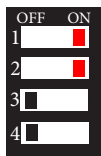

RS232 converter in «RS485» and vice-versa

ETHERNET/WIFI port disabled.
Set the serial ports to 9600 n-8-1.

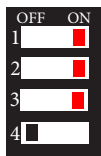

Enable the option to configure the ethernet/wifi board via browser

Set the serial ports to 9600 n-8-1



Attention:
every time you change the operating mode, the board resets the standard default settings.

USB support data saving board

installation integrated inside the scale.

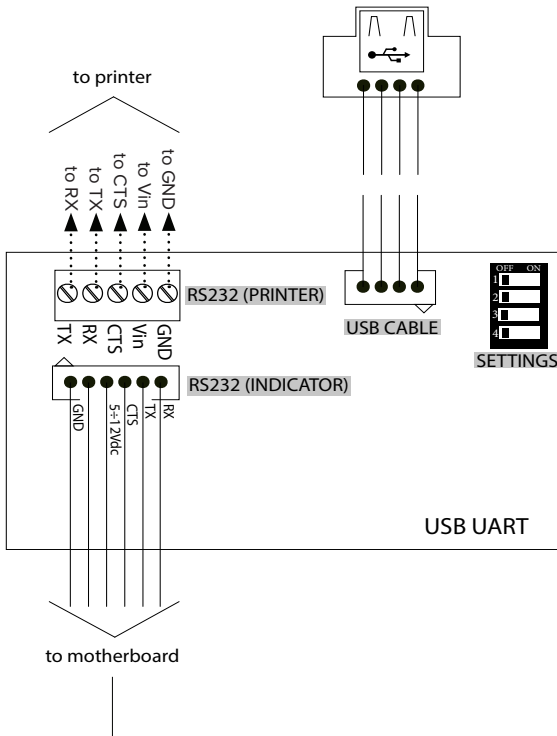

The AMP connector enables you to rapidly connect and supply the CPU board of the weighing indicator

Version for installation on a DIN bar

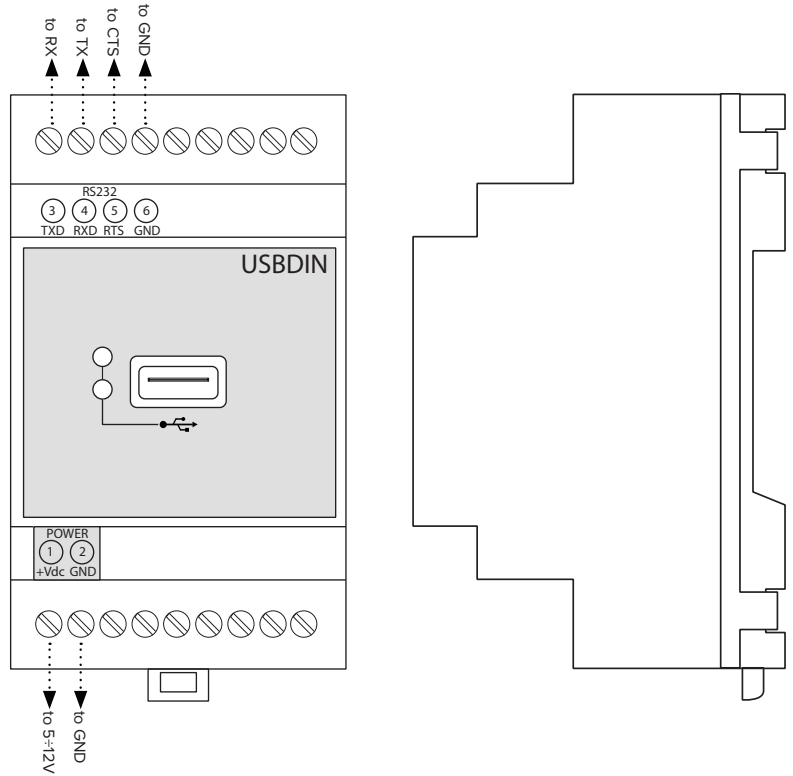

SETTINGS:

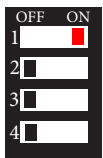

Configure the baud rate, parity, bit number and stop bit:

- ON = 38400-E-8-1
- OFF = 9600-N-8-1

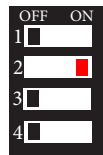

Enable CTS for a connected printer:

- ON = CTS managed
- OFF = CTS not managed



LED description:

RED LED:

ON = Print in progress

Flashing = USB not detected

GREEN LED:

Slow flashing = Ready

Quick flashing = USB or printer not detected



RADIO communication board

installation integrated inside the scale

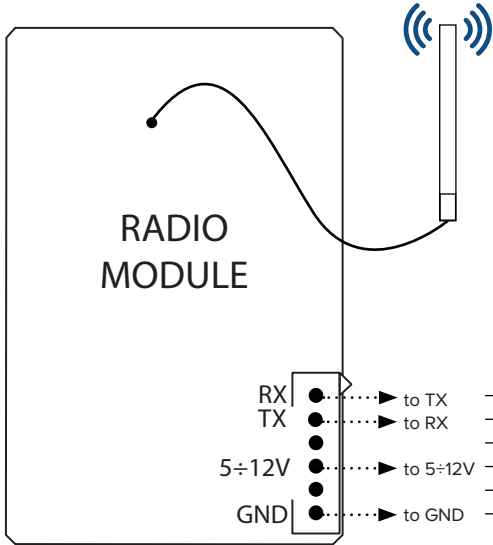

TTL version

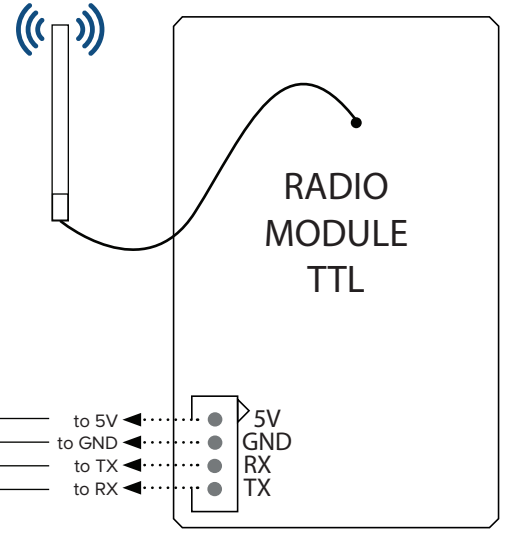

to motherboard

The AMP connector enables you to rapidly connect and supply the CPU board of the weighing indicator.

PROFIBUS communication board

Version for installation on a DIN bar

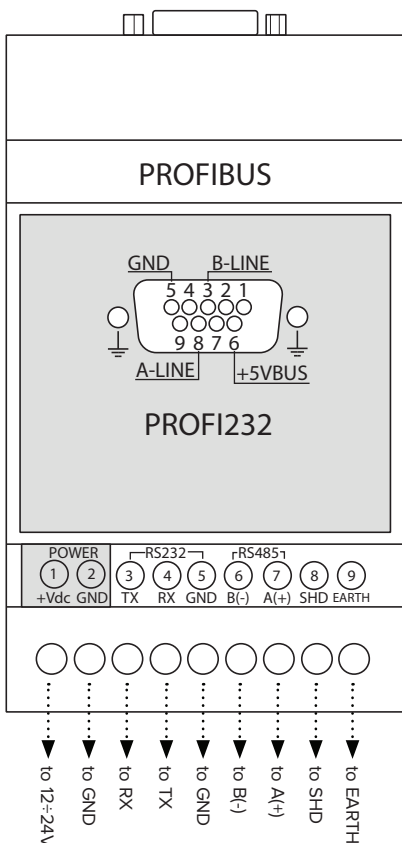

It is possible to connect the indicator to RS232 or RS485

BLUETOOTH communication board

Installation integrated inside the scale.

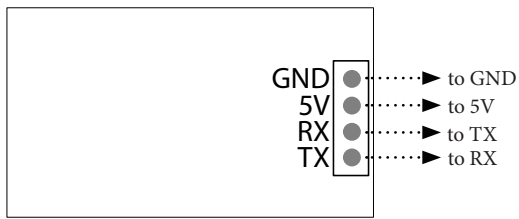

i

The AMP connector enables you to rapidly connect and supply the CPU board of the weighing indicator.

RADIO REMOTE CONTROL board

Installation integrated inside the scale.

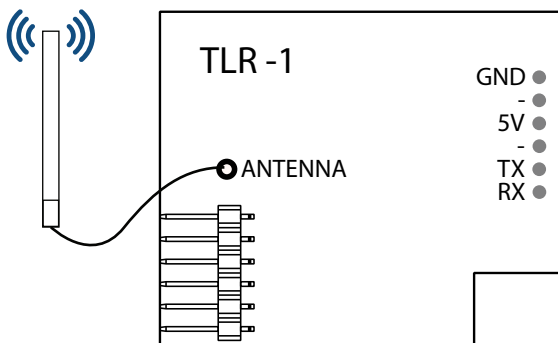

i

Connect the module to the indicator's COM2 via a strip connector situated on the board with a wire or directly to the CPU board with a tulip connector situated under the board.

Circuit breaker against electrostatic loads

Installation integrated inside the scale.

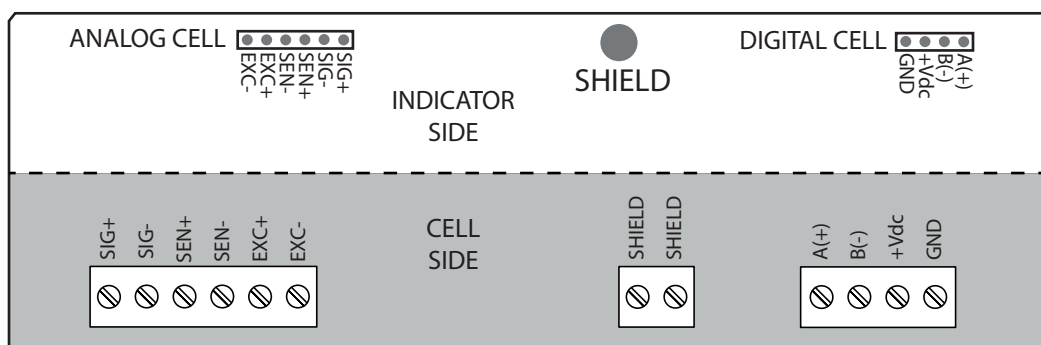

Analog output

Installation integrated inside the scale. 0-4mA/0-10Vdc.
Assemble the board facing towards the indicator's CPU.

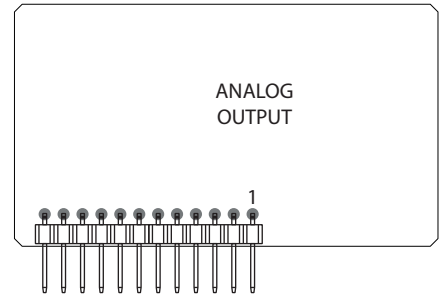

1

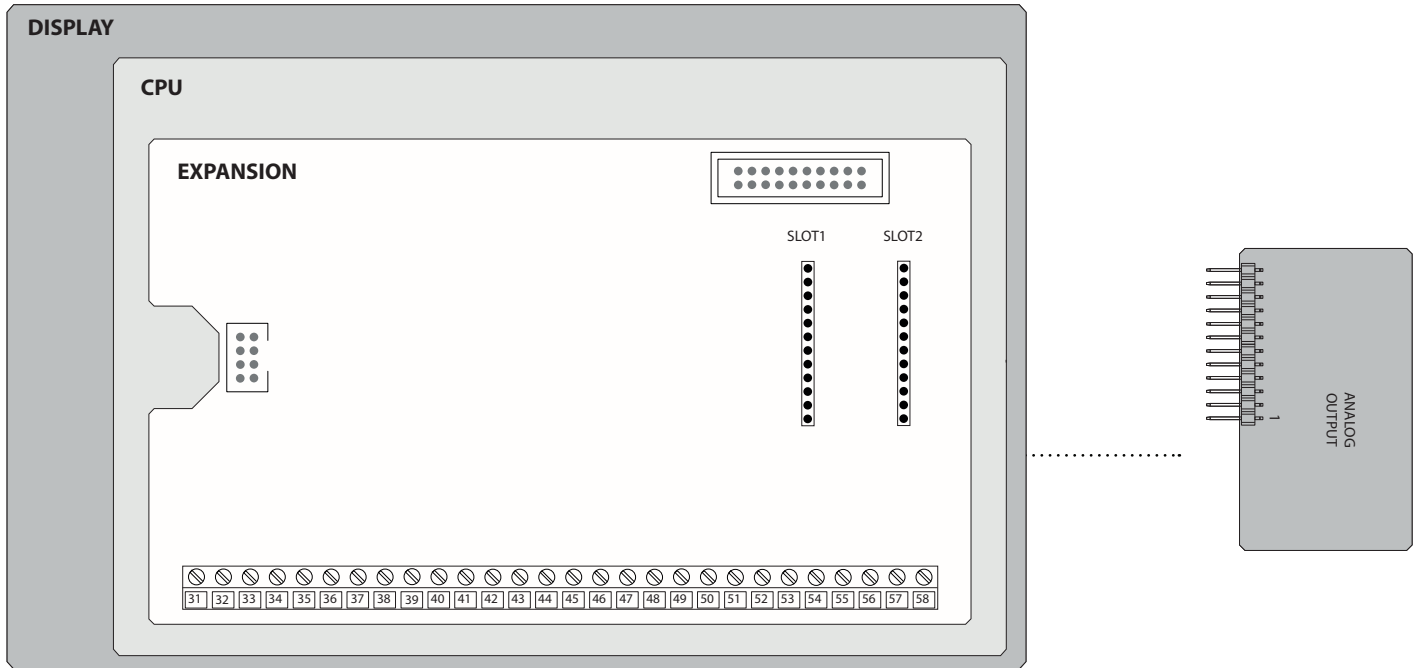

2

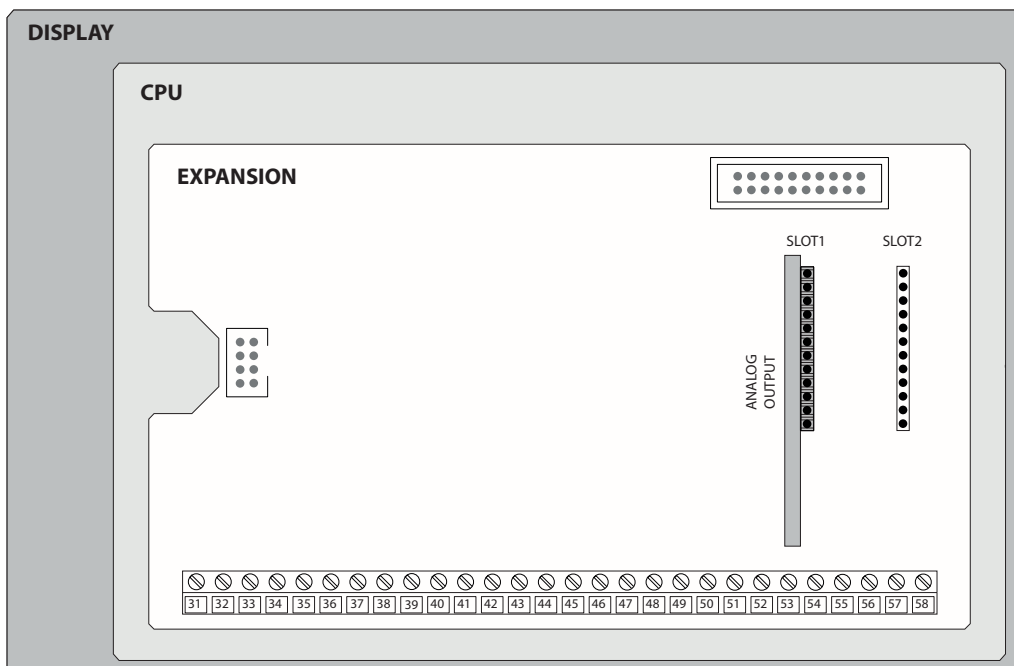

Traffic light

Integrated and indicator

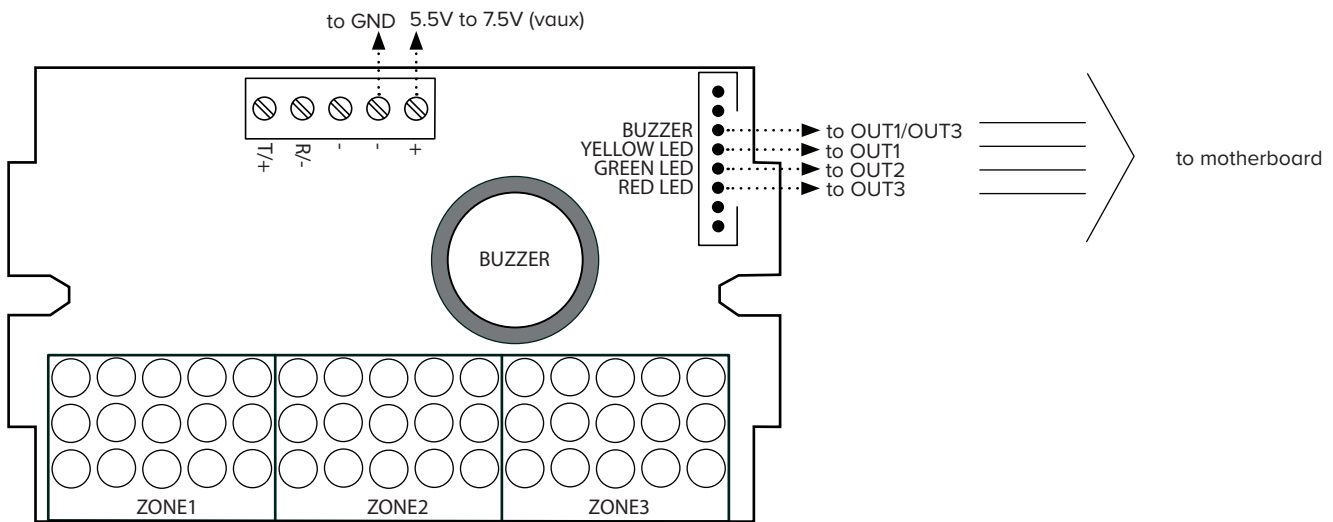

Chip 485

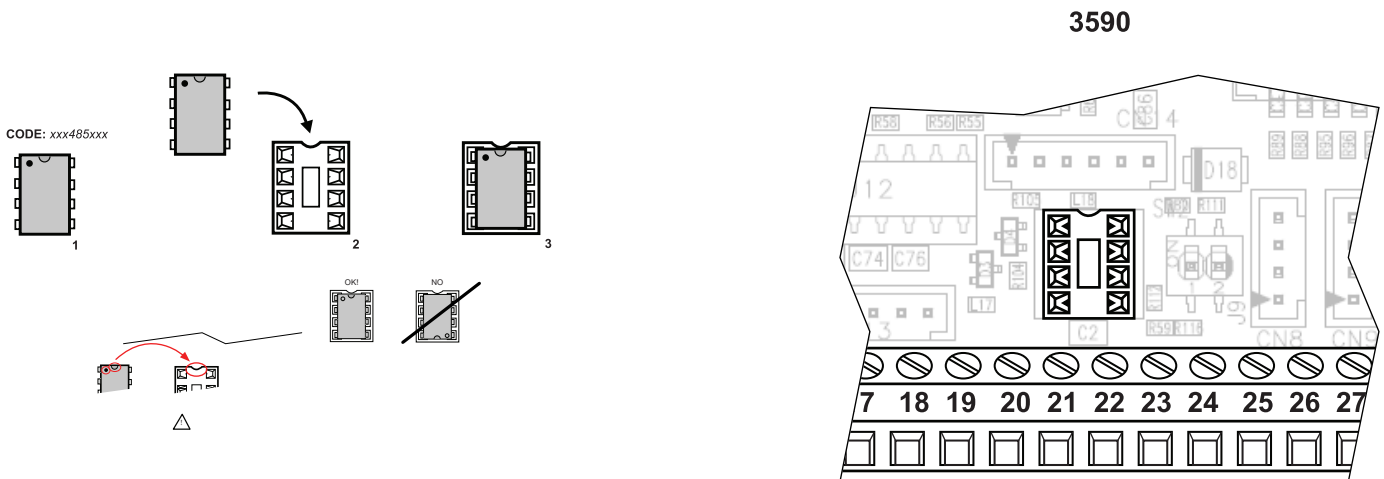

RS485 opto-isolated board

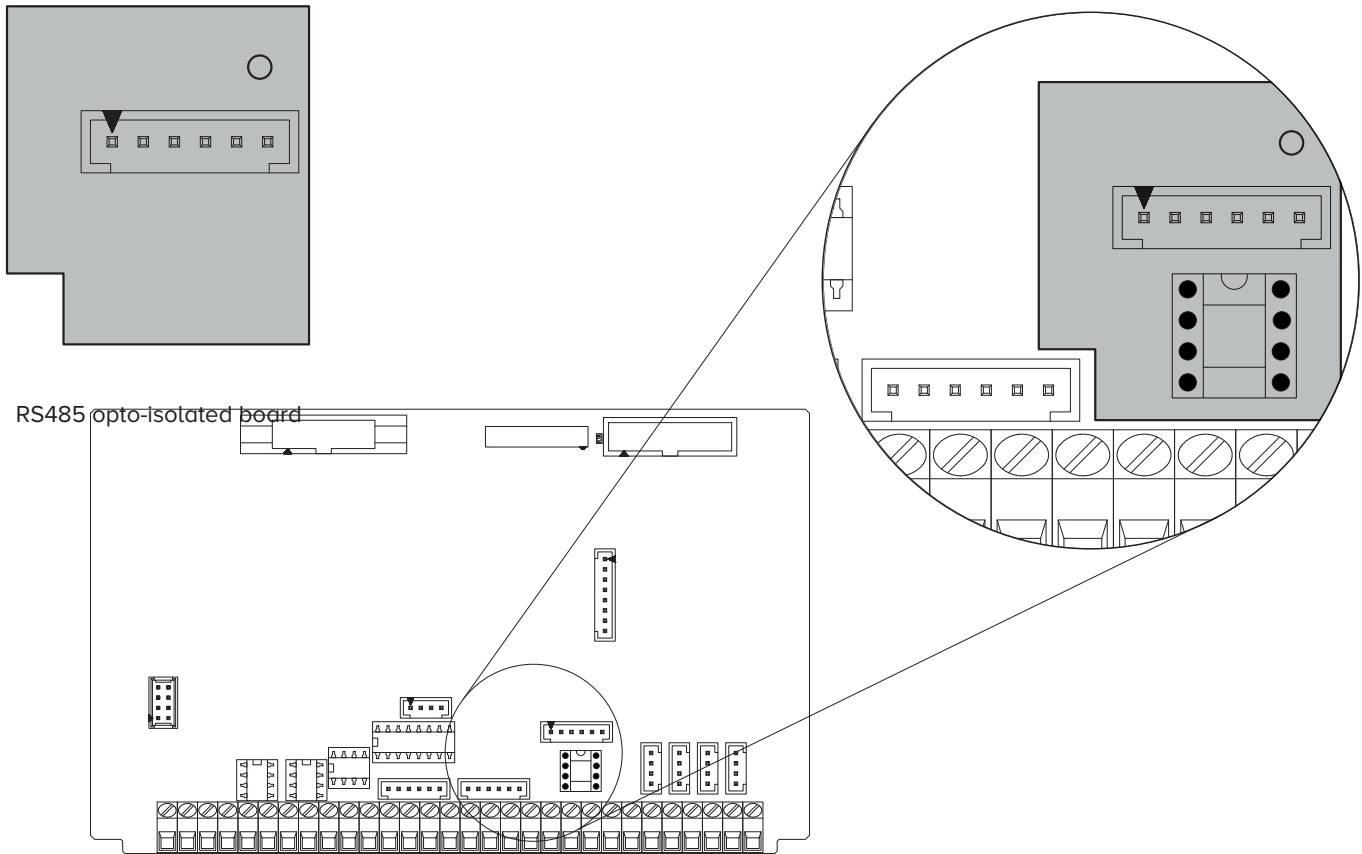

Display board

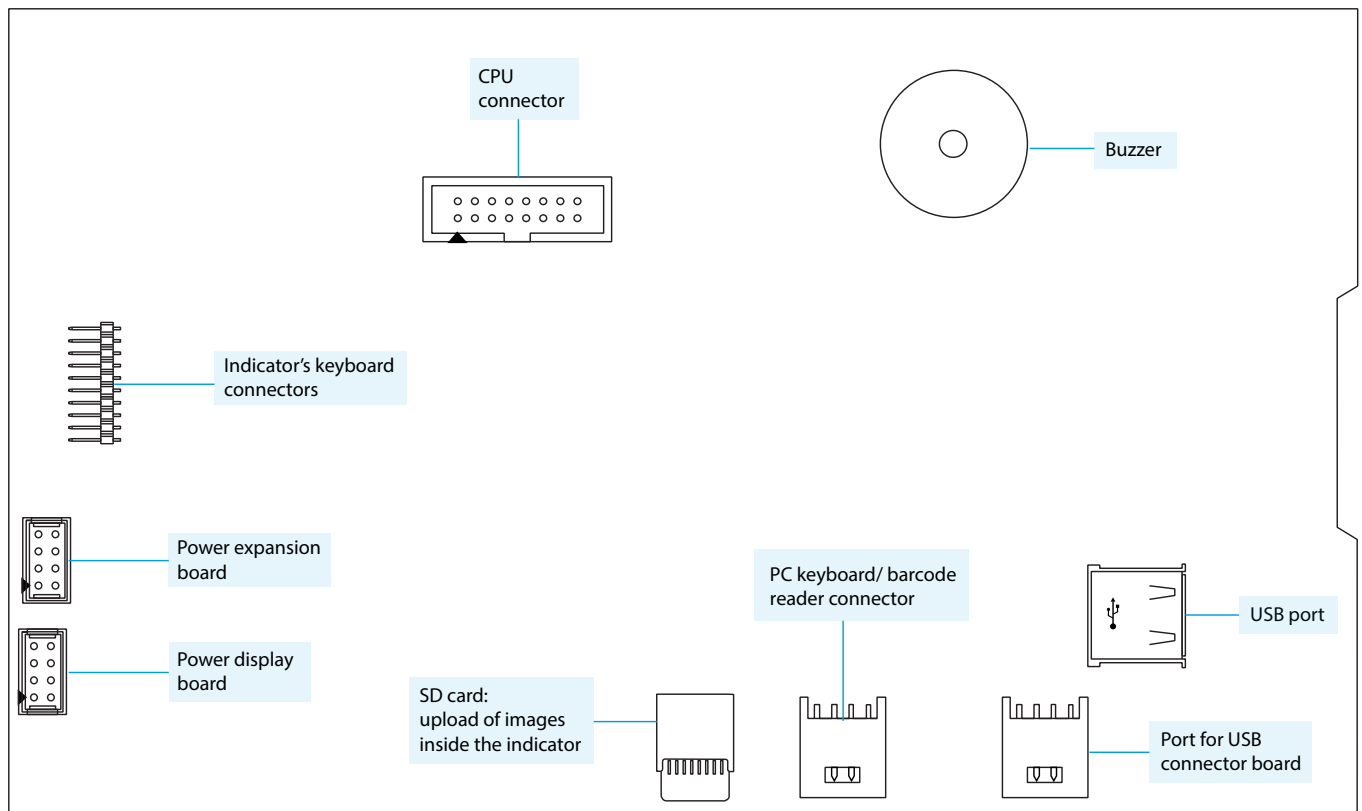



HEAD OFFICE

Via della Fisica, 20
41042 Spezzano di Fiorano, Modena - Italy
Tel. +39 0536 843418 - Fax +39 0536 843521
info@diniargeo.com

CUSTOMER SERVICE

Via dell'Elettronica, 15
41042 Spezzano di Fiorano, Modena - Italy
Ph. +39 0536 921784 Fax +39 0536 926654
service@diniargeo.com

Authorised service centre stamp

